

**Sehr schlanke Lautsprecherzeile** in 100-V-Technik, bestückt mit vier 5-cm-Lautsprechern. Wandbefestigung mit Montagewinkeln an den Stirnseiten oder mit optionaler Gelenkhalterung. Nach Montage in alle Richtungen schwenkbar. Weiß lackiertes Aluminiumgehäuse und Abdeckgitter (RAL 9010). Die EZ 40.7 ist auf Anfrage auch in anderen RAL-Farben lackiert erhältlich.

**Zubehör:** Gelenkhalterung (Art. No. 50403)

*Extremely slim speaker system using 100 V technology equipped with four 5 cm drivers. Wall-mounting is possible using wall brackets on the end faces or universal-joint brackets (optional). Can be swivelled in any direction after fitting. White painted aluminium cabinet and protective grille (RAL 9010). EZ 40.7 can be supplied painted in other RAL colours on request.*

**Accessories:** Universal-joint bracket (Art. No. 50403)

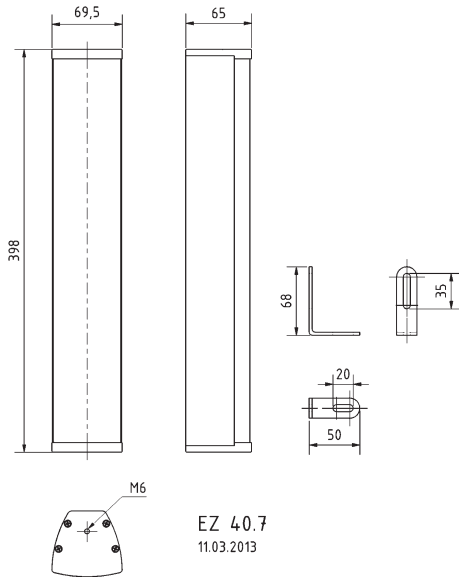

Art. No. 50403

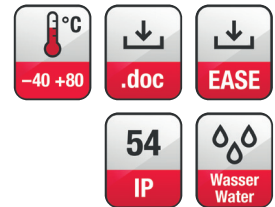
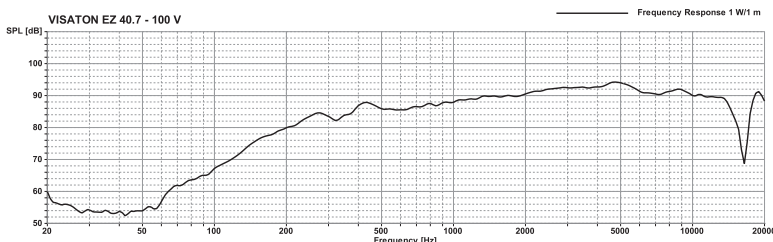
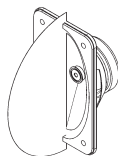
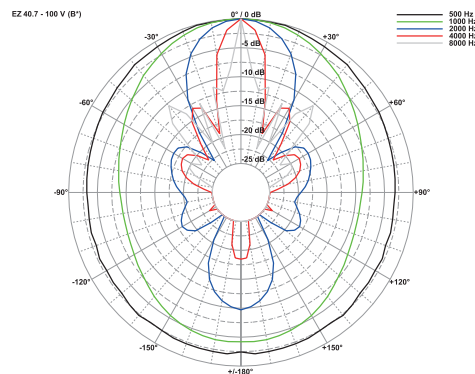
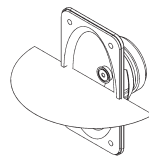
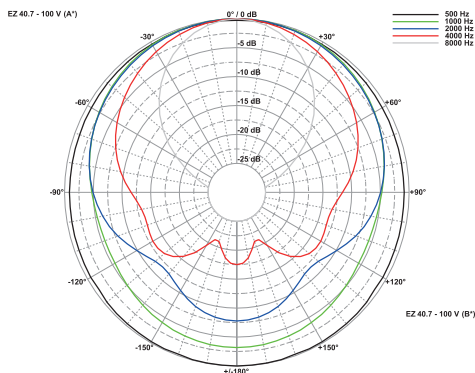

**Technische Daten / Technical Data**

Trafoanpassung Transformer matching	20/10/5 W
Schalldruckpegel Sound pressure level	94 dB (1 W/1 m) @ 5000 Hz
Abstrahlwinkel (-6 dB) Opening angle (-6 dB)	111° hor. / 33° vert. / 4000 Hz
Übertragungsbereich (-10 dB) Frequency response (-10 dB)	230-20000 Hz
Mittlerer Schalldruckpegel Mean sound pressure level	91 dB (1 W/1 m)
Max. Schalldruckpegel Max. sound pressure level	104 dB (20 W/1 m)
Farbe Colour	RAL 9010
Gewicht netto Net weight	2,1 kg